

EDGE

BY HAMMEL

M40



Fittings

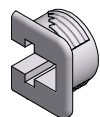

F1
(6200007)



F2
(6200006)

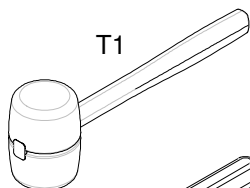

T1

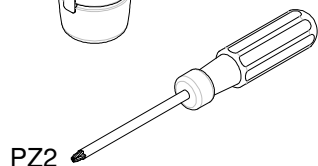

PZ2

Placering af fast hylde.

Placement of the mandatory shelf.

Platzierung des obligatorischen Fachboden.

Emplacement de l'étagère fixe.

Placering av den fasta hylla.

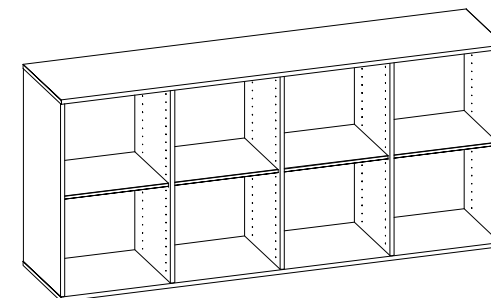
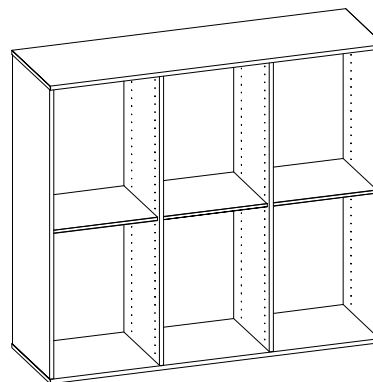

På side 2 er vist, hvor den faste hylde kan placeres.

At page 2 you can see where the mandatory shelf has to be placed.

An Seite 2 können Sie die Platzierung des obligatorischen Fachboden sehen.

À la page 2 nous avons montré où il faut placer l'étagère fixe.

På sida 2 visas hur den fasta hyllan kan placeras.

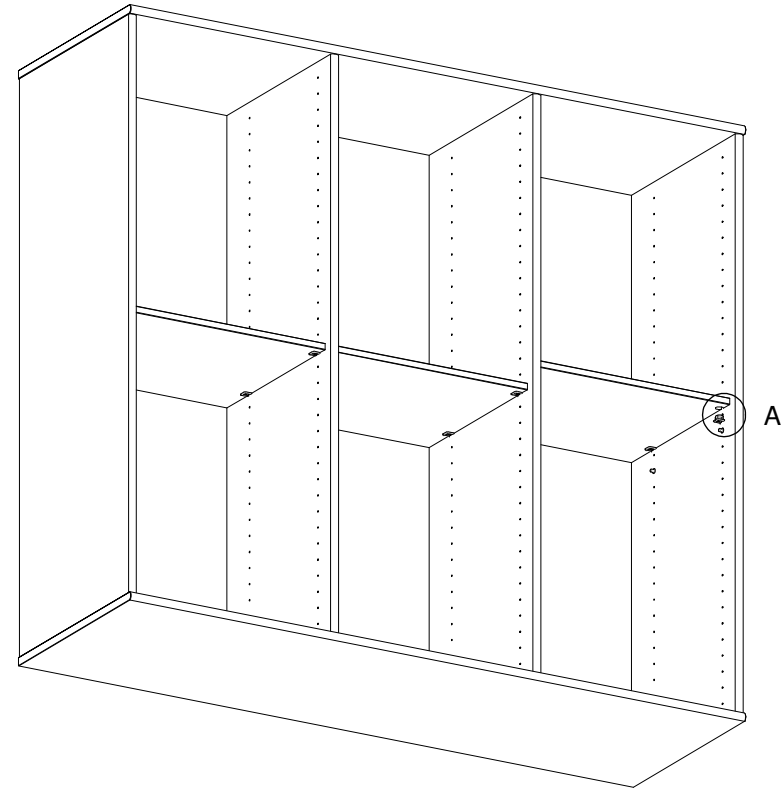
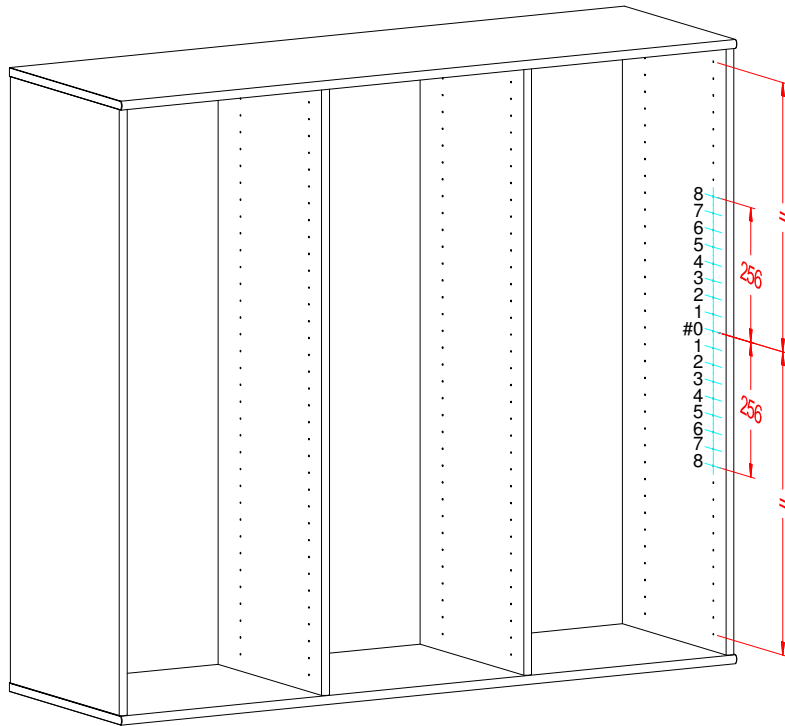

Hul #0 er det midterste hul i modulets højde.
Hylden kan placeres valgfrit i hullerne 0 1 2 3 4 5 6 7 8. Opad eller nedad.

Hole #0 is the center hole in the cabinet height.
The shelf is to be placed in either hole No. 0 1 2 3 4 6 7 up or down.

Bohrung #0 ist das Zentrum in der Korpushöhe.
Der Fachboden muss in der Bohrung 0 1 2 3 4 5 6 7 8 nach oben oder unten platziert werden.

Trou #0 est le trou du milieu de la hauteur de la module.
Les étagères peuvent être placées - à option - dans les trous 0 1 2 3 4 5 6 7 8.
Vers le haut ou bas.

Hål #0 är det mittersta hålet i stommen.
Hyllan kan placeras i valfritt hål 0 1 2 3 4 5 7 eller 8. Upp eller ned.

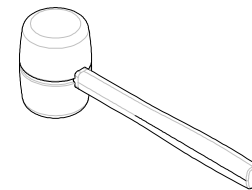

For F1: Brug gummihammer.
For F1: Use rubber mallet.
Für F1: Gummihammer verwenden.
Pour F1: Utilisez un marteau en caoutchouc.
For F1: Använd gummihammare.

